



Hydropan Operation and Maintenance Manual



Attention

Before using the control panel, you must read the information in this manual carefully.

1. Product Information

Hydropan control panel is a panel that can control and protect up to three 7.5 kW pumps, display the operating status of the pumps and error details on the screen, and provide monitoring and control via Modbus RTU protocol. The panel includes a specially designed main board and a 2x16 character LCD display. In addition to this, it is user friendly with its specially developed comprehensive software, status LEDs, and control buttons.

2. General Features

- Easy to use menu in Turkish and English
- Can be used for up to three three phase 7.5 kW or single phase 2.2 kW pumps
- 8-bit microprocessor-based design
- 16 MHz operating frequency
- 2x16 character LCD with white screen
- Displays date and time on the screen
- Measures and displays three phase voltage values.
- Ability to set high and low voltage protection values
- Displays pump ready, active, and error status on the screen
- Displays pump current on-screen during operation
- Ability to set pump low and high current protection values
- Ability to set pump low and high current protection time
- Automatic reset on low current faults
- Automatic and manual operation selection
- Operates as long as the test button is held down in manual operation
- Float switch to guard against dry operation
- Additional low current protection against dry operation
- Displays all error statuses on screen
- Audible error status alarms
- Displays pump operating times on screen
- Ability to perform sequential or timed equal aging according to need
- Simultaneous aging in 2 pump circulation applications
- Password protection against unauthorized interventions
- Error record memorizes the last 98 errors with date and time
- Ability to transfer system operating data to the automation system using RS 485 communication protocol via modbus and control via modbus
- Ability to work with pressure transmitter
- Ability to transfer pump operation and error information to the automation system with dry contacts

- PTC protection
- 220V siren output activated when error occurs
- Compatible with deep well pump applications
- Automatic weekly test function
- Information with an additional float switch to guard against overflow
- Ability to set max limit for number of switches allowed in 1 hour
- IP65 protection class
- Can be used as a co-aging panel in circulation pump applications

3. Commissioning and Considerations

1- Proper and reliable transportation, storage, operation, and maintenance are essential for smooth and safe operation of the panel. Only certified electricians are authorized to install or operate this equipment.

2- Occupational health and safety rules must be observed to prevent injuries.

3- Rotating shafts and electrical equipment are dangerous. All electrical work must comply with national and local electrical codes. Installation, start-up, and maintenance must be carried out by trained and qualified personnel. Failure to follow these instructions may result in serious injury.

4- Check the board for any damaged or missing items.

5- Before starting on the electrical connections, disconnect the mains power and make sure that the power is disconnected using measuring instruments.

6- Before energizing the panel, make sure that the mains voltage is balanced between the phases and complies with the permissible voltage values for the panel.

7- Make sure that the mains supply and the electric motor have the same voltage.

8- Make sure that the cross-section of the main power cable coming to the panel is selected in accordance with the total motor power to be operated. The use of low cross-section cables can cause injuries, faults, and fire.

9- Before opening the plastic cover, check that there is no liquid, dust, etc. around the unit.

10- When the screws on the four corners of the front plastic cover are removed, be careful not to let the front cover fall to the ground and not to strain the cable in between. After opening the front cover, continue working safely by sliding the cover up and fixing it to the upper screw slots of the back box with the lower screws of the front cover.

11- After opening the front plastic cover, feed all cables through the appropriate sleeves and make sure that any unused sleeves are properly closed.

12- The appliance must be properly grounded. Connect the main earthing cable and the electric motor housing earthing cables with an earthing resistance value that meets international standards to the ground bus.

13- Before the electric motor is energized via the panel, the motor must be checked according to international standards. Ensure that the electric motor windings are intact, the motor is ready to operate safely, and the terminal connections are made correctly. Energizing a malfunctioning electric motor via the panel will also cause panel malfunction.

14- The cable between the panel and the electric motor must be carefully checked for any damage or defect before energizing. Use of unsuitable cables may result in personal injury or panel malfunction.

15- After connecting the electrical cables to the appropriate terminal blocks, make sure that the terminal block screws are properly tightened (tighten to a maximum torque of 0.7 Nm) and that the cables do not come out of the terminal block when pulled lightly.

16- After the electrical connections are made, remove the front cover again and slide it down to replace it. Make sure that the plastic cover is closed properly after the electrical connections have been made. Hydropan can be damaged by pollution. Never leave the Hydropan with the cover open.

17- After energizing the Hydropan, set low and high current limit values from the menu for electric motor protection for each motor separately according to the motor power. For current settings, please refer to the current settings menu descriptions on the following pages.

18- In electric motors, having more than the maximum number of switches allowed by the electric motor manufacturers according to the motor power may cause a malfunction. For this reason, the maximum number of switches to be allowed according to the motor power connected to the panel must be set in the menu. To set the number of switches, please refer to the switch count settings menu descriptions on the following pages.

19- After the necessary settings have been made, the system should be put into automatic mode and checked that it is working properly. When operating under full load, ensure that no more than 10% more current is drawn than the nominal current indicated on the motor nameplate, and when the suction valve is closed, the panel switches to low current error and stops the motor.

20- If the system is to operate with a pressure switch, the pressure switch settings should be made according to the system's operating curve. In automatic mode, confirm in practice that the pumps can start and stop according to the pressure switches.

21- After all checks are completed, check that the suction and discharge valves are open, bleed any air in the pump, reset the panel, and ensure that it works properly in automatic mode.

22- Please contact our authorized technical services for all your questions.

23- Malfunctions that may occur if the above items are not complied with will not be covered by the warranty.

4. Panel Descriptions

4.1. Front Panel Descriptions and Dimensions

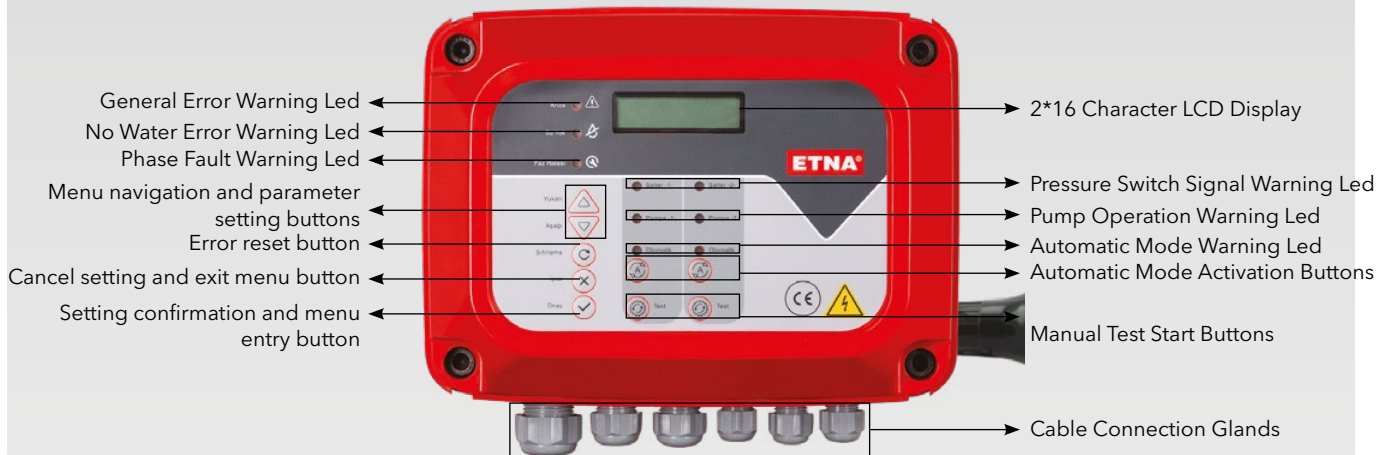
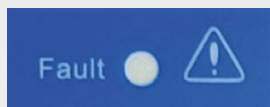
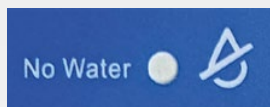

Figure 1. Hydropan Control Panel - Exterior View



General error notification LED: When any error condition occurs in the system (low current, high current, phase loss, no water, etc.) this LED lights up and the error detail is displayed on the main screen.



No water error notification light: This LED lights up when the water level is low. The no water error is given when the float or level electrodes connected to the panel's float terminals are open circuit when the water level decreases. When the tank or well is full of water, the no water error disappears automatically.

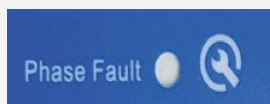

Phase error notification LED: When phase loss, phase asymmetry, high or low voltage, etc. occur in the mains supply voltage, the phase error LED lights up and the error detail is displayed on the main screen.

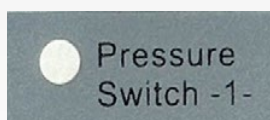

Pressure switch 1 signal notification LED: When the line pressure drops to the pressure at which the pump will be activated, the run command comes from pressure switch 1 and this LED lights up. When the run command comes from pressure switch 1, the pressure switch 1 terminals on the panel are short-circuited between themselves and the switch 1 LED lights up. If the panel is in automatic mode (automatic LED is on) and there is no error preventing operation, the pump is activated when the switch 1 LED is on. The pressure switch setting must be made in practice according to the system operating point.

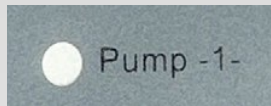

Pump 1 activated notification LED: This LED lights up when pump 1 is activated.

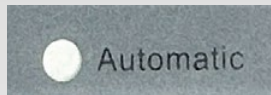

Automatic mode activated notification LED: This LED is on when automatic mode is activated. Press the A button to select automatic - manual mode. In order for the pumps to be switched on and off automatically, automatic mode must be activated and the automatic LED must be on.

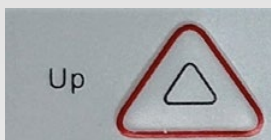

Up button: Used to scroll through the menu and make parameter settings.

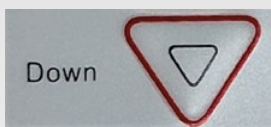

Down button: Used to scroll through the menu and make parameter settings.

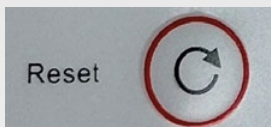

Reset button: This is an error reset button. When any error occurs in the panel, eliminate the condition causing the error, make the necessary checks, then reset by pressing and holding this button for 3 seconds. After the error has been reset, monitor the system to ensure it is operating properly. Do not perform error reset by pressing the reset button repeatedly while the condition causing the error continues. Doing so will result in damage to the electric motor or pump system.

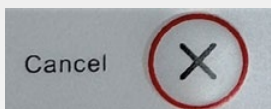

Cancel button: Used to exit the menu and return without saving the settings. It can also be pressed once just to silence the signal when an error occurs.

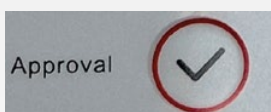

Confirm button: Used to enter the menu and save the settings. After the setting is made in the menu, the setting must be saved by pressing the confirm button.



Mode selection button: Automatic - manual mode selection button. Pressing the button activates the automatic mode and the automatic LED lights up. When the system is intended to operate automatically, the automatic LED should be on. When the A button is pressed while the automatic LED is on, the automatic mode is deactivated and the manual mode is switched on, the automatic LED goes out and the pump is not activated automatically even if it is needed.

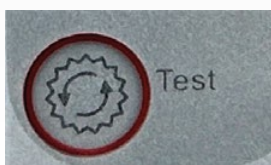

Test button: In manual mode (automatic mode disabled), the pump is activated as long as the test button is held down. During commissioning, it is used by the service to make current adjustments and control motor rotation direction, air intake, etc. The test button will not activate the pump while the automatic LED is on.

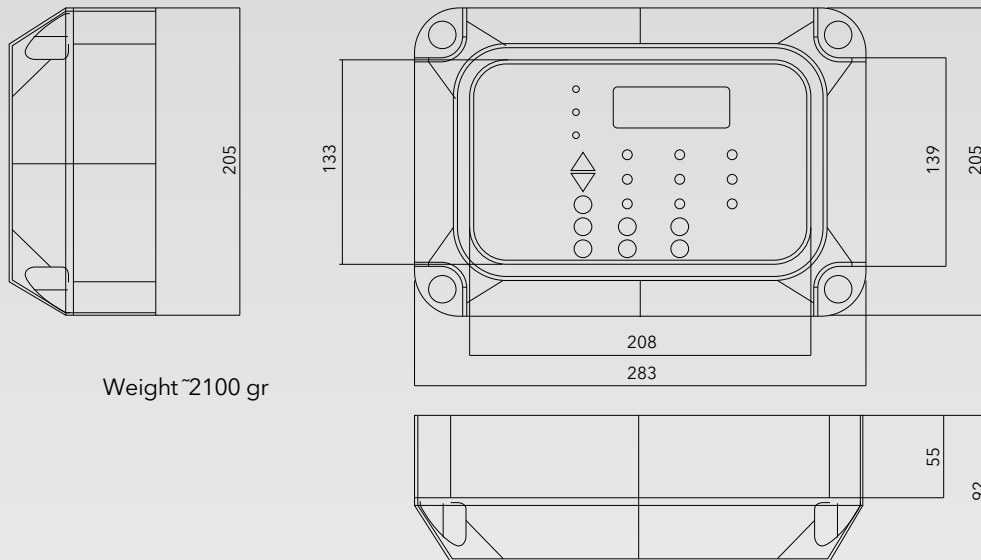

Weight ~2100 gr

Figure 2. Panel Dimensions

4.2. Panel Interior View and Terminal Block Descriptions

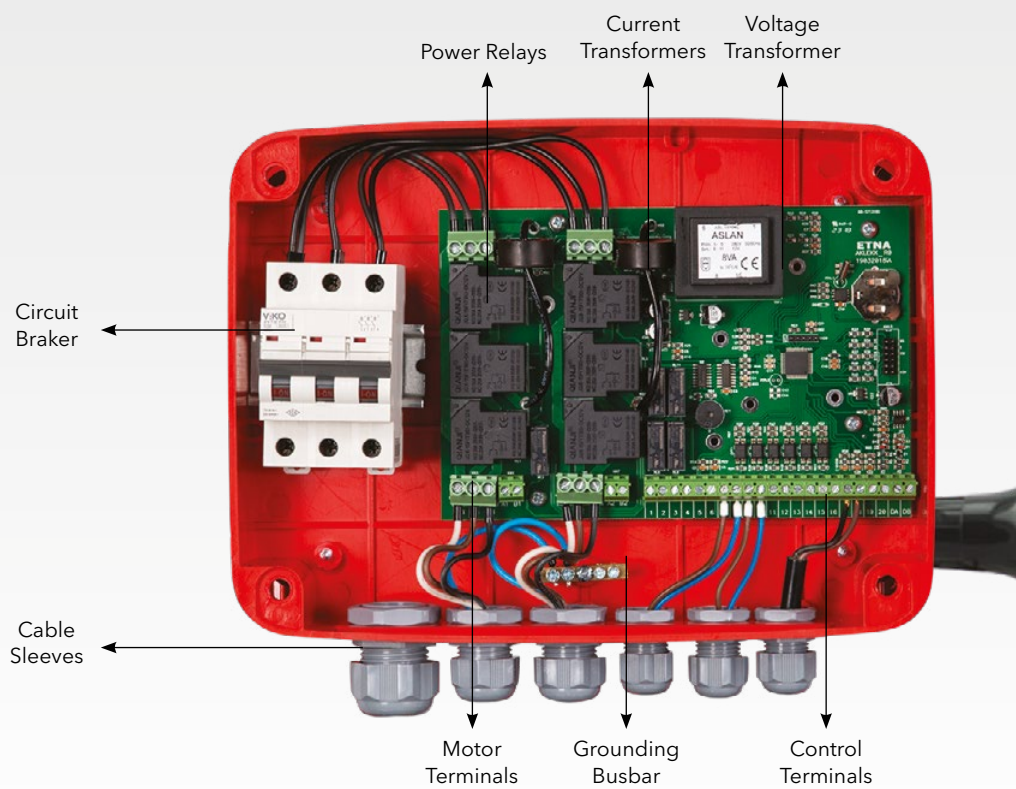

Figure 3. Hydropan Control Panel-Interior View

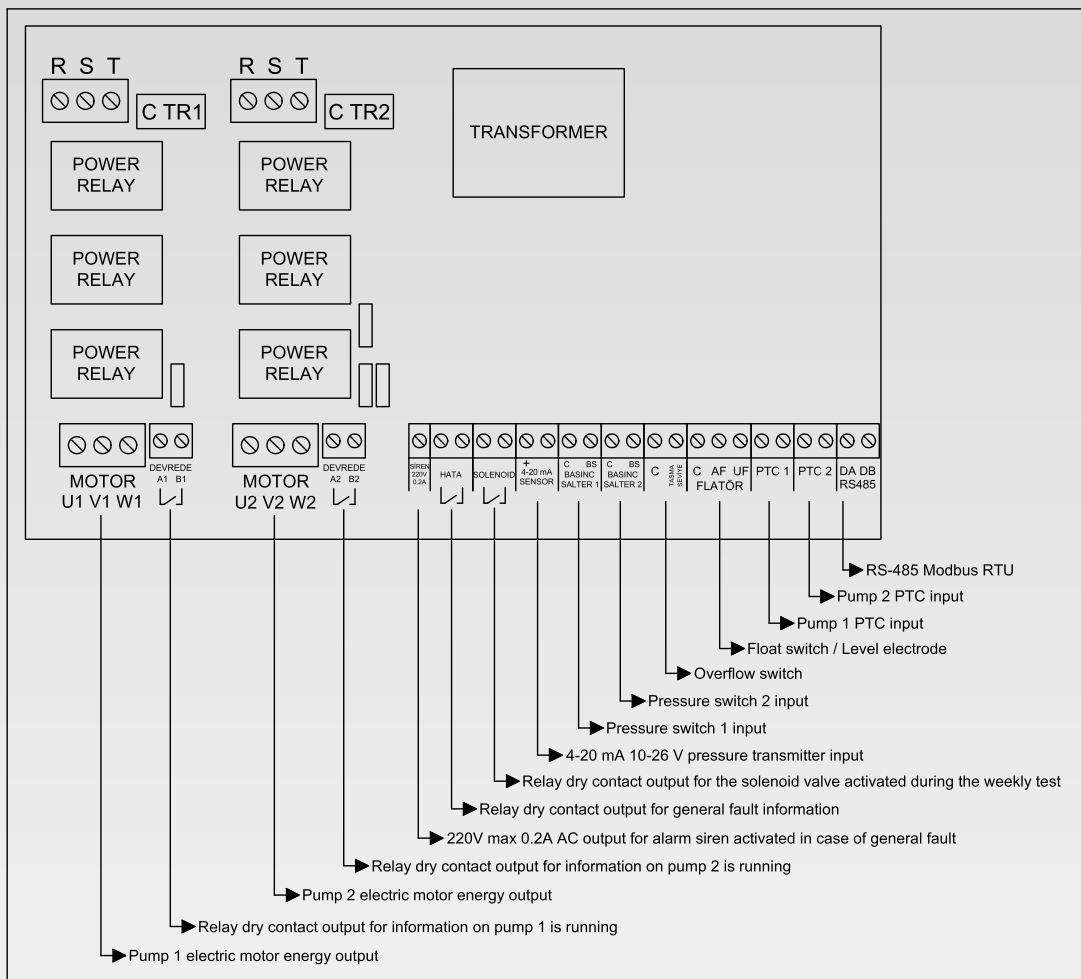

Figure 3.1. Hydropan Control Panel - Terminal block descriptions

Note: The base model Hydropan 4D panel does not include the working with pressure transmitter function, the communication via modbus RTU function, 220V alarm siren output, PTC protection, overflow protection, and relay dry contact outputs. The base model Hydropan 4D panel only has the standard features required to operate pump systems such as pressure switch inputs and float inputs. All features shown in the terminal block descriptions above are available in the Full model Hydropan 4DF panel.

Note: Floater terminals are used for water level measurement. When closed type floaters are used, AF and UF terminals should be short-circuited with the help of a cable, one end of the floater should be connected to the C terminal and the other end to the AF terminal. Floater adjustment should be applied according to the tank used.

If level electrodes are to be used for water level measurement in deep wells, 3 level electrodes should be connected to UF (upper float), C (com-common, bottom float), AF (lower float) terminals. The bottom level floater connected to the C terminal should be connected at least half a meter above the top of the pump, the low level electrode connected to the AF terminal should be connected at least half a meter above the bottom level electrode, and the upper level electrode connected to the UF terminal should be connected to the upper level where the water is required to be filled and rerun after the pump stops. While the pump is running, when the water level drops to the level electrode connected to the AF terminal, the pump stops, and starts again when the water is filled again and comes into contact with the level electrode connected to the UF terminal. The settings of the level electrodes should be applied according to the tank.

Improper adjustment of the level electrodes may result in failure of the pump or electric motor, which is not covered by the warranty.

Examine the connection types that need to be made according to various applications from the circuit diagrams section on the following pages.

4.3. Hydropan Models

Model	Number of Pump	Dimensions (mm)	Usage Type	Panel Color	Supply Voltage	Internal MCB	Alarm Siren	Built-In Permanent Capacitor for Single Phase PSC Motor	Relay Outputs for Pump Running and General Fault Information	Working with a Pressure Transmitter	Modbus RTU
Hydropan 2S	1	170x195	Domestic Water	Blue	Single phase	X	X	X	√	X	X
Hydropan 2SP	1	170x195	Fire Pilot Pump	Red	Single phase	X	√	X	√	X	X
Hydropan 4S	1	170x195	Domestic Water	Blue	Three phase	X	X	X	√	X	X
Hydropan 4SP	1	170x195	Fire Pilot Pump	Red	Three phase	X	√	X	√	X	X
Hydropan 2D	2	283x205	Domestic Water	Blue	Single phase	√	X	X	√	√	√
Hydropan 2DS	1	283x205	Domestic Water	Blue	Single phase	√	X	X	√	√	√
Hydropan 2DSC	1	283x205	Domestic Water	Blue	Single phase	√	X	√	√	√	√
Hydropan 4D	2	283x205	Domestic Water	Blue	Three phase	√	X	X	√	√	√
Hydropan 4DS	1	283x205	Domestic Water	Blue	Three phase	√	X	X	√	√	√
Hydropan 4DA	2	283x205	Fire Pump with Alarm Kit	Red	Three phase	√	√	X	√	√	√
Hydropan 4DSA (4SA)	1	283x205	Fire Pump with Alarm Kit	Red	Three phase	√	√	X	√	√	√
Hydropan 2T	3	283x205	Domestic Water	Blue	Single phase	√	X	X	√	√	√
Hydropan 2TA	3	283x205	Fire Pump with Alarm Kit	Red	Single phase	√	√	X	√	√	√
Hydropan 4T	3	283x205	Domestic Water	Blue	Three phase	√	X	X	√	√	√
Hydropan 4TA	3	283x205	Fire Pump with Alarm Kit	Red	Three phase	√	√	X	√	√	√

5. Menu



Figure 4. Panel Model and Software Version

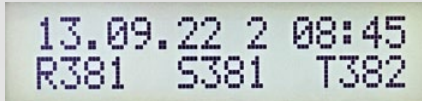

Figure 5. Main Operation Screen

5.1. Password Menu

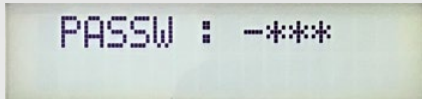

Figure 6. Password Screen

5.2. Pump Durations Menu

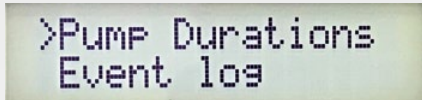

Figure 7. Pump Durations Menu



Figure 8. Pump Durations Detail Menu

5.3. Event Log Menu

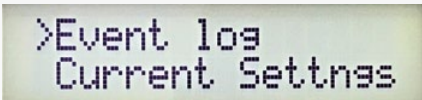

Figure 9. Event Log Menu



Figure 10. Event Log Detail Menu

When the panel is energized, the model and software version codes are displayed on the LCD screen as shown on the left. In the main screen that follows, the date, day (day of the week is indicated by a number equivalent, 1: Monday, 2: Tuesday, 3: Wednesday, etc.), time and voltage values of each phase are displayed.

When the "Approval" button is pressed on the main work screen, the image shown on the side will appear on the screen. Use this screen, which is used to prevent unauthorized access, to access the settings menu by entering "1234" as the password using the up, down, and approval buttons.

When the cursor is on the "Pump Durations" line in the menu and the "Approval" button is pressed, the screen shown in Figure 8 is displayed and the operating time of each pump can be read from the screen in hours:minutes.

When the cursor is on the "Event log" line in the menu and the "Approval" button is pressed, the screen shown in Figure 10 is displayed. Use the up and down arrows to view the last 98 errors. The first row will always display the most recent error.

5.4. Current Settings Menu

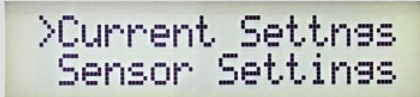

Figure 11. Current Settings Menu

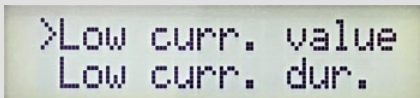

Figure 12. Current Settings

When the cursor is on the “Current settings” line in the menu and the “Approval” button is pressed, the screen shown in Figure 12 is displayed. Use this menu to set the “Low curr. value” (low current value), “Low curr. dur.” (low current delay time), “High curr. val. (high current value), “High curr. dur.” (high current delay time) values.

Low current and high current limit values should be set for each pump separately. When operating under full load, ensure that the current drawn is

no more than 10% more than the nominal current indicated on the motor nameplate, and that when the suction valve is closed, the panel gives a low current error at the end of the delay time and stops the motor. Faults that may occur due to setting the low and high current limits incorrectly are not covered by the warranty.

5.4.1. Low Current Setting Menu

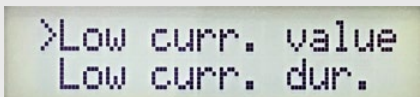

Figure 13. Low Current Setting Menu

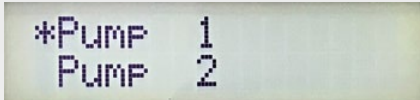

Figure 14. Low Current Pump Selection Screen

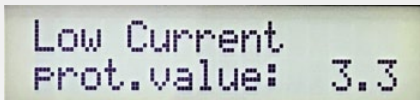

Figure 15. Low Current Setting Screen

Use this menu (low curr. value) to set the current lower limit value for all pumps. The low current protection function gives the pumps extra protection in cases such as no water coming to the pump suction, operating at maximum pressure for a long time due to pressure switch malfunction, etc. The electric motor is stopped and a low current error is given when the current it draws during operation falls below the value set in this menu.

When low current protection occurs in booster systems, it is generally desired that the system is restarted automatically and periodically. The Hydropan panel has an automatic restart feature in low current protection. The standby period following low current protection caused by

repetitions is periodically extended. This time, which was 2 minutes in the first trial, is adjusted to 50 minutes in the 5th trial. If the low current condition persists after repetitions, the system is blocked. After the system is blocked, make the necessary checks and reset the error by pressing and holding the reset button for 3 seconds then make sure that the system is working correctly.

To set the low current limit value, bleed the pump and close the valve on the discharge line then start the pump by pressing and holding the test button in manual mode. When the pump operates with the discharge valve closed, use the pressure gauge to confirm the pressure in the line. While the test button is held down, the current drawn by the relevant pump motor is displayed on the main screen. The low current protection value must be saved by entering 0.2 A less than the value shown on the display. For example, if the current shown on the display is 5 A when the test button is pressed and held while the discharge valve is closed, 4.8 A should be set as the low current protection value. After the low current protection value is set, you must open the valve in the discharge line. It is recommended that the current settings are made in practice according to the values at which the pump set will operate. Damage to the pump group due to incorrect settings is not covered under warranty.

5.4.2. Low Current Delay Time Setting Menu

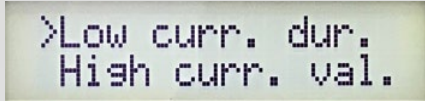

```
>Low curr. dur.  
High curr. val.
```

Figure 16. Low Current Delay Time Menu

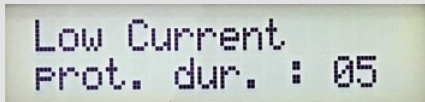

```
Low Current  
prot. dur. : 05
```

Figure 17. Low Current Delay Time Display

The low current delay time menu (low curr. dur.) is used to set the delay time before a low current error occurs when the current drawn by the electric motor is lower than the value set in the low current value menu. If the current drawn is less than the low current limit value for the length of the low current delay time, a low current error will occur after the time set in this menu.

5.4.3. High Current Setting Menu

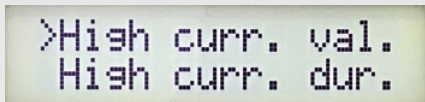

```
>High curr. val.  
High curr. dur.
```

Figure 18. High Current Setting Menu

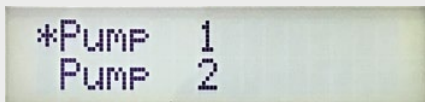

```
*PUMP 1  
PUMP 2
```

Figure 19. High Current Pump Selection Screen

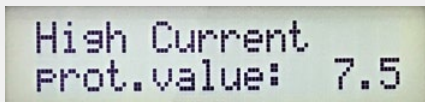

```
High Current  
prot. value: 7.5
```

Figure 20. High Current Setting Display

Use this menu (high curr. val.) to set the current upper limit value for all pumps. The high current protection function protects the electric motor against high current. When the current drawn by the electric motor during operation exceeds the value set in this menu, it is stopped and a high current error is given. After the fault that caused the high current draw in the pump system is eliminated, press and hold the reset button for 3 seconds to reset the fault then make sure that the system is operating correctly.

The high current protection limit value must be set a maximum of 10% higher than the rated operating current indicated on the motor nameplate. For example, if the rated current on the motor nameplate is 10 A, the high current protection value should be set to maximum 11 A in this menu. Make sure that the set high current

limit value does not exceed the nominal operating current written on the motor nameplate by more than 15%. It is recommended to set the high current limit value in practice according to the operating values of the electric motor in the pump system.

5.4.4. High Current Delay Time Setting Menu

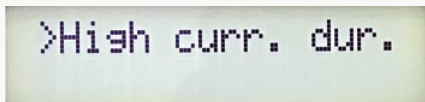

```
>High curr. dur.
```

Figure 21. High Current Delay Time Menu

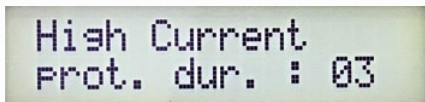

```
High Current  
prot. dur. : 03
```

Figure 22. High Current Delay Time Display

This menu (high curr. dur.) is used to set the delay time before a high current error is given when the current drawn by the electric motor is higher than the value set in the high current value menu. If the current drawn exceeds the high current limit value for the length of the high current delay time, a high current error will be given after the time set in this menu.

5.5. Sensor Settings Menu

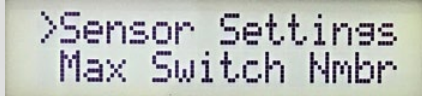

```
>Sensor Settings
Max Switch Nmbr
```

Figure 23. Sensor Settings Menu

When the cursor is on the "Sensor settings" line in the menu, pressing the "Approval" button accesses the menu where the parameters for operation with pressure transmitter are set.

2 wired, 12-24VDC 4-20 mA 1 pressure transmitter can be connected.

5.5.1. Sensor Status Menu

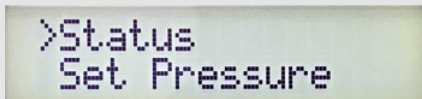

```
>Status
Set Pressure
```

Figure 24. Sensor Status Menu

Use the "Status" menu in the sensor settings to activate or deactivate the operation with pressure transmitter mode.

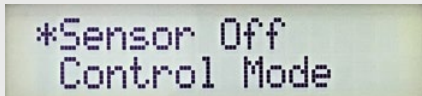

```
*Sensor Off
Control Mode
```

Figure 25. Sensor Status Setting Screen

When the "Sensor off" option is selected in the "Status" menu, the operation with pressure transmitter mode is deactivated and the pumps operate according to the pressure switches connected to the "Switch" input.

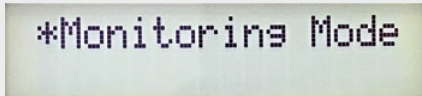

```
*Monitoring Mode
```

Figure 26. Sensor Status Setting Screen

Selecting "Control mode" activates the operation with pressure transmitter mode. Operation with pressure transmitter works using the parameters set in the sensor settings menu.

When "Monitoring mode" is selected, the pumps operate according to the pressure switches connected to the "Switch" input, but the line pressure can be monitored via the pressure transmitter. The system must have a pressure transmitter to use the monitoring mode. In this mode the pressure transmitter displays only the line pressure. Additionally, only monitoring mode is available when the operating mode is circulation.

5.5.2. Set Pressure Menu

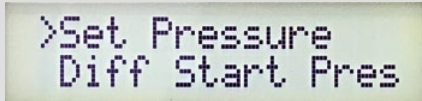

```
>Set Pressure
Diff Start Pres
```

Figure 27. Set Pressure Menu

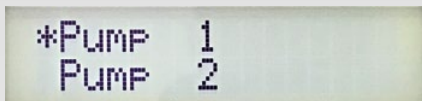

```
*PUMP 1
PUMP 2
```

Figure 28. Set Pressure Pump Selection Screen

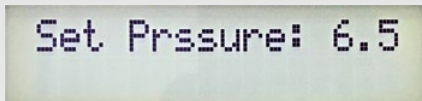

```
Set Prssure: 6.5
```

Figure 29. Set Pressure Setting Screen

Use the Set pressure menu to set the set pressures of the pumps in the system. The set pressure of each pump must be set separately. When the line pressure reaches the set pressure set in this menu, the running pump is stopped. The set pressure can be set within the measuring range of the pressure transmitter, provided that it is not less than the minimum protection pressure limit and not more than the maximum protection pressure limit. It must be adjusted according to the system's demand point.

5.5.3. Differential Start Pressure Menu

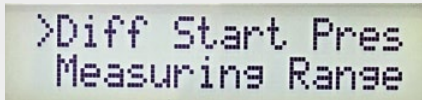

```
>Diff Start Pres
Measuring Range
```

Figure 30. Differential Start Pressure Menu

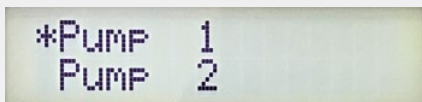

```
*PUMP 1
PUMP 2
```

Figure 31. Differential Pressure Pump Selection Screen

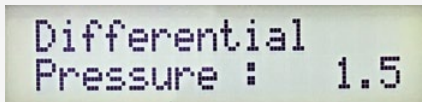

```
Differential
Pressure : 1.5
```

Figure 32. Differential Pressure Setting Screen

Use the differential start pressure menu to set the differential pressures at which the pumps will operate. The pump stops when the line pressure reaches the set pressure and starts when the set pressure drops by as much as the differential start pressure. For example, if the set pressure is set to 6 bar and the differential start pressure is set to 1.5 bar, the pump starts when the line pressure drops below 4.5 bar and stops when it reaches 6 bar. Each pump can be set individually.

5.5.4. Measuring Range Menu

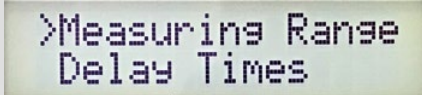

```
>Measuring Range
Delay Times
```

Figure 33. Measurement Range Menu

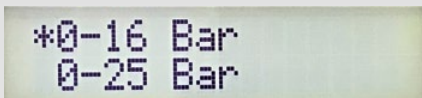

```
*0-16 Bar
0-25 Bar
```

Figure 34. Measurement Range Selection Screen

This menu is used to define the measuring range of the pressure transmitter in the system to the panel. Use this menu to select the measuring range of the pressure transmitter to make accurate pressure measurements. If the pressure transmitter can measure in the range of 0-16 bar, select the 0-16 bar range in this menu.

5.5.5. Delay Times Menu

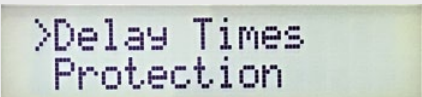

```
>Delay Times
Protection
```

Figure 35. Delay Times Menu

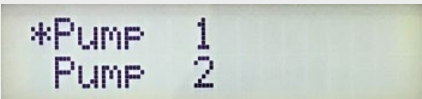

```
*PUMP 1
PUMP 2
```

Figure 36. Delay Times Pump Selection Screen

This menu is used to set the delay times for switching the pumps on and off. After the line pressure reaches the set pressure, the pump is deactivated after the deactivation time set in this menu. After the line pressure drops below the set pressure's wake-up pressure, the pump is activated after the activation time set in this menu. The activation and deactivation times of each pump can be set individually according to need.



```
>Start Delay
Stop Delay
```

Figure 37. Setup Screen For Start and Stop Delay Times

5.5.6. Protection Settings Menu

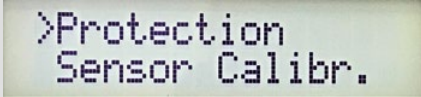

Figure 38. Protection Settings Menu

This menu is used to set the maximum protection pressure, maximum protection pressure delay time, minimum protection pressure, minimum protection pressure delay time, and the number of repetitions for minimum pressure error automatic reset.

5.5.6.1. Maximum Protection Pressure Menu

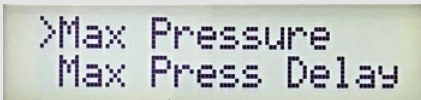

Figure 39. Maximum Protection Pressure Menu

This menu is used to protect the system from high pressure. If the line pressure is higher than the maximum protection pressure for the length of the maximum protection pressure delay time, a high pressure error will be given. The error will clear automatically when the line pressure drops below the maximum protection pressure value. The maximum protection pressure cannot be set outside the pressure transmitter's measuring range.

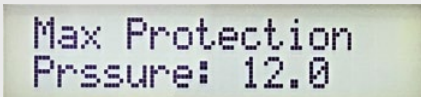

Figure 40. Maximum Protection Pressure Setting Screen

5.5.6.2. Maximum Protection Pressure Delay Time Menu



Figure 41. Maximum Pressure Delay Time Menu

This menu is used to set the delay time before a high pressure error is given when the line pressure is higher than the maximum protection pressure. If the line pressure is higher than the maximum protection pressure for the length of the maximum protection pressure delay time, a high pressure error will be given. The maximum protection pressure delay time cannot be shorter than the pump deactivation time.



Figure 42. Maximum Pressure Delay Time Setting Screen

5.5.6.3. Minimum Protection Pressure Menu

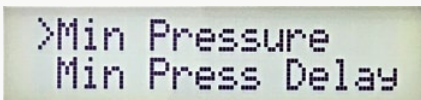

Figure 43. Minimum Protection Pressure Menu

This menu is used to protect the system from low pressure (running without water). If the line pressure is lower than the minimum protection pressure for the length of the minimum protection pressure delay time, a low pressure error will be given. The error will clear automatically when the line pressure rises above the low protection pressure value. The minimum protection pressure cannot be set greater than the set pressure and outside the pressure transmitter's measuring range.

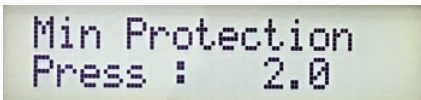

Figure 44. Minimum Protection Pressure Setting Screen

5.5.6.4. Minimum Protection Pressure Delay Time Menu

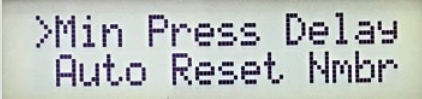

Figure 45. Minimum Pressure Delay Time Menu

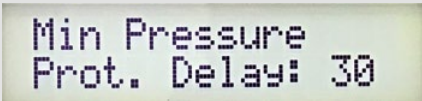

Figure 46. Maximum Pressure Delay Time Setting Screen

This menu is used to set the delay time before a low pressure error is given when the line pressure is lower than the minimum protection pressure. If the line pressure is lower than the minimum protection pressure for the length of the minimum protection pressure delay time, a low pressure error will be given.

5.5.6.5. Auto Reset Menu



Figure 47. Repeat Count Menu

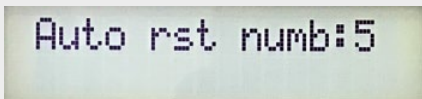

Figure 48. Repeat Count Setting Screen

When low pressure protection occurs in booster systems, it is generally desired that the system restarts automatically and periodically. Repeat count is a function that allows the system to be restarted after a waiting period at the end of the low pressure protection. The number of repetitions can be set between 0 and 5. The standby period following low pressure protection caused by repetitions is periodically extended. This time, which was 2 minutes in the first trial, is adjusted to 50 minutes in the 5th trial. If the

system pressure does not rise after the set number of repetitions, the system is blocked. After the system is blocked, make the necessary checks and reset the error by pressing and holding the reset button for 3 seconds. If the number of repetitions (auto rst numb.) is selected as 0, no retry is made when a low pressure error occurs and the system is blocked at the first low pressure error.

5.5.7. Sensor Calibration Menu



Figure 49. Sensor Calibration Menu



Figure 50. Sensor Calibration Setting Screen

This menu is used to calibrate the pressure transmitter. The calibration coefficient set in this menu is used to equalize the value indicated by the calibrated manometer and the value measured by the pressure transmitter. Divide the value read on the manometer by the value indicated by the pressure transmitter, then enter the resulting coefficient in this menu and complete the calibration by pressing the confirm button.

5.5.8. Sensor Reset Menu

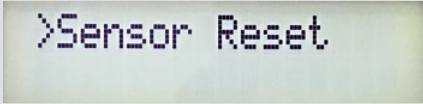

Figure 51. Sensor Reset Menu

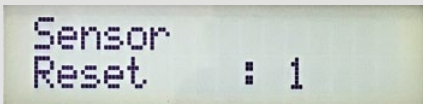

Figure 52. Sensor Reset Screen

Use this menu to reset the previously calibrated value. If the system has been previously calibrated and the old pressure transmitter has been replaced with a new pressure transmitter, reset the sensor by entering "sensor reset:1" in the menu and pressing the confirm button.

5.6. Permitted Number of Maximum Switches Menu

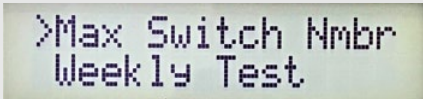

Figure 53. Max Switch/Hour Menu

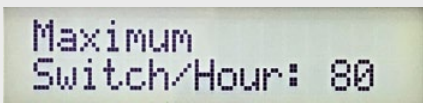

Figure 54. Max Switch/Hour Screen

This menu (max switch nmb.) is used to set the maximum number of switches allowed in 1 hour. To prevent malfunctions that may occur due to too frequent switching in electric motors, the maximum number of switches allowed in 1 hour should be set according to the power of the electric motor. Set the switching limit according to the table below then press the confirm button to save the maximum number of switches allowed in 1 hour. The time to wait between 2 sequential starts is set by dividing 1 hour (60 minutes) by this set value. For example, if the maximum switching/hour value is set to '10' in this program, the time between starts will be 6 minutes, so a maximum of 10 starts per hour is possible. If an attempt is made to start the electric motor earlier, a switching error will be given and the motor will not start. After the set time, the switching error will clear automatically and the motor will continue to run safely. The switch count limit program can be set between 0 and 80 according to the electric motor power. When set to '0', the switch count protection program is disabled. The maximum permissible number of switches must be set according to the motor power. Malfunctions caused by making more switches than permitted will not be covered by the warranty.

Motor power (kW)	0.25 - 3	4 - 7.5	11 - 15	18.5 - 22	30 - 37	45 - 75	90 - 160
Recommended maximum number of switches per hour	60	40	30	24	16	8	4

Table 1. Switch Number Setting Table

5.7. Weekly Test Menu

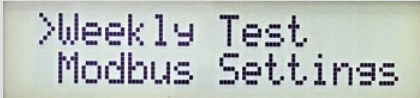

Figure 55. Weekly Test Menu

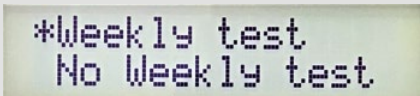

Figure 56. Weekly Test Activation Screen

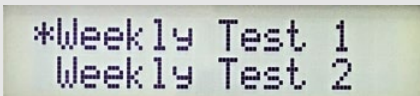

Figure 57. Weekly Test Selection Screen

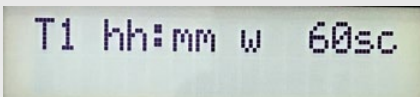

Figure 58. Weekly Test Setting Screen

The weekly test menu has been created to prevent malfunctions that may occur due to long periods of inoperability in booster pump systems. On the day and time set in this menu, the electric motors are started sequentially and stopped automatically after the set time.

Use the weekly test menu to activate and deactivate the weekly test program.

After the weekly test is set as available, enter the test time, test day (1: Monday, 2: Tuesday, 3: Wednesday etc.) and test duration respectively and save by pressing the confirm button. The pumps will be automatically activated at the specified time and date every week for the specified period of time and a weekly test will be performed. The pump controller must be in automatic mode for the weekly test to take place. If there is a solenoid valve in the discharge collector of the pump system, the solenoid valve can be activated preventing pressurization of the line after the solenoid valve during the weekly test by activating the solenoid valve relay during the weekly test. The solenoid valve, which is activated during the weekly test, can also be used for drainage purposes. When the weekly test starts, the solenoid valve can be opened to direct the pressurized water to the discharge line. The weekly test duration can be set between 10 and 120 seconds. Care should be taken not to operate the pumps at high pressure for long periods due to the weekly test. It is recommended to perform the weekly test for a maximum of 60 seconds.

5.8. Modbus Settings Menu

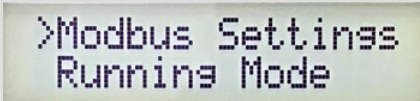

Figure 59. Modbus Settings Menu

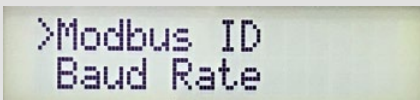

Figure 60. Modbus Settings Screen



Figure 61. Modbus Settings Screen

Bring the cursor to the "Modbus settings" line in the menu then press the "Approval" button to access the menu where modbus settings are made.

Use the Modbus settings menu to set the Modbus ID, baud rate, and parity bit values.

Reading and writing can be done with the Modbus RTU protocol. The register table is shared in Table 3 below. With the Modbus 06 Write Single Register function, writing can be done to the specified addresses and panel control can be provided via Modbus.

The Modbus register table is on the following pages.

5.9. Running Mode Menu

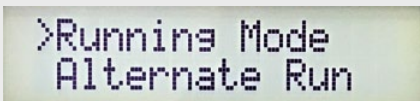

Figure 62. Operation Mode Selection Menu

Hydropan panels have operating modes that can adapt to various applications. The type of system to be controlled by the panel can be selected from the operating mode menu. Booster, with stop float, circulation wet, circulation dry modes are available. Mode selection must be made in accordance with the system to be controlled. Failure due to incorrect mode selection is not covered by the warranty.

5.9.1. Booster Mode



Figure 63. Booster mode Screen

In booster systems, the operating mode must be selected as booster.

In booster mode, pumps are activated and deactivated with the start or stop command from the pressure switch inputs or pressure transmitter. In booster mode, the reservoir water level is controlled with the help of float switch. Pressure switch settings and float level settings must be made according to the system.

Booster mode can also be used in drainage applications by connecting float switches to the pressure switch inputs for drainage pumps. Connection diagrams for various applications are shown in the circuit diagrams section.

5.9.2. With stop float mode

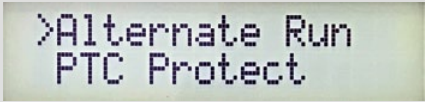

```
>Alternate Run
PTC Protect
```

Figure 64. Alternate Run Menu

When the down button is pressed in the running mode menu, the cursor is moved to the "With stop float" line and the "Confirm" button is pressed, the "Stop Float" operating mode is activated.

This mode is used in applications where the pump is required to operate until all of the deep reservoirs are emptied.

In stop float mode, 1 start float for each pump is used to start the pumps and 1 common stop float is used to stop the pumps. Start floats are positioned at the upper water level and stop float at the lower water level. The pumps that are activated with the help of the floats connected to the pressure switch terminals are stopped with the stop command coming from the float which is located at the bottom level in the reservoir and goes down with the decrease in water level and 'No Water' alarm is not given.

In stop float mode, the pressure switch 1 and 2 terminals can be short circuit, float or level probes can be connected to the float terminals and the pumps can run as long as there is water in the tank and stop without alarm when the water runs out.

Not suitable for booster applications.

5.9.3. Circulation Wet Mode

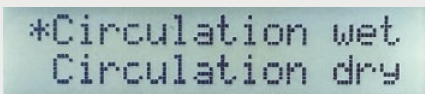

```
*Circulation wet
Circulation dry
```

Figure 65. Circulation wet mode

When the down button is pressed in the operating mode menu, the cursor is moved to the "Circulation Wet" line and the "Confirm" button is pressed, the "Circulation Wet" operating mode is activated.

It is specially designed for co-aging of wet rotor frequency inverter circulation pumps. In Hydropan panels with 2 pumps, this mode alternately operates the pumps so that 1 pump is on and 1 pump is standby and provides co-aging. In 3-pump Hydropan panels, it operates the pumps alternately with 2 pumps on and 1 pump standby and provides co-aging. The pumps in the system are automatically switched on and off in sequence depending on the co-aging time set in the menu, thus preventing the same pump from running continuously. How long the pumps will remain in operation can be set in the "time set" section of the co-aging menu.

To automatically start the equal aging application in circulation modes, the tasma seviye and the adjacent C terminal must be short-circuited. If this is not done, a "waiting start" warning will appear on the screen. The start-stop dry contact information from the boiler systems can be connected to these terminals to ensure control. If there is no external start-stop information, the overflow level terminals must be bridged.

Fault relay dry contact outputs of circulation pumps with frequency inverter can be connected to ptc inputs on Hydropan panel. After the faulted pump is automatically stopped by the frequency inverter, Hydropan panel activates the other circulation pump. The faulted pump is not de-energized for fault detection. The energization of the pump that goes into fault is automatically cut off after the fault is eliminated or can be cut off by pressing the automatic (A) button.

Pumps that are in automatic mode in circulation pumps co-aging application are activated sequentially depending on the time set in the menu. When the automatic mode is deactivated, the relevant pump can be activated manually by pressing the test button once, the test button must be pressed again to deactivate it.

It can also be connected to the automation system and when the pumps are not in automatic mode, pump 1 is activated when the pressure switch 1 terminals are short-circuited with the relay dry contact output and pump 2 is activated when the pressure switch 2 terminals are short-circuited with the relay dry contact output. When the pressure switch terminals are open-circuited, the pumps are deactivated.

Automatic mode can be activated and deactivated separately for each pump via modbus rtu. In this way, if the co-aging time is set to 1 hour or more in the co-aging menu, when 2 pumps are set to automatic mode, 1 pump is activated and co-aging is provided. If the co-aging time is set to 0, when 2 pumps are set to automatic mode, 2 pumps are activated and operation is provided. In addition, after manual mode selection via modbus rtu, pumps can be switched on and off separately.

5.9.4. Circulation Dry

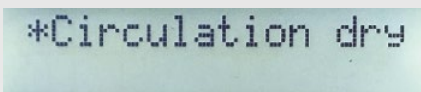

Figure 66. Circulation dry mode Screen

When the down button is pressed in the operating mode menu, the cursor is moved to the "Circulation Dry" line and the "Confirm" button is pressed, the "Circulation Dry" operating mode is activated.

Specially designed for co-aging of circulation pumps in direct start motors without dry rotor frequency

inverter. In Hydropan panels with 2 pumps, this mode alternates the pumps so that 1 pump is on and 1 pump is standby and provides co-aging. In 3-pump Hydropan panels, it alternates the pumps so that 2 pumps are on and 1 pump is standby and provides co-aging. The pumps in the system are automatically switched on and off in sequence depending on the co-aging time set in the menu, thus preventing the same pump from running continuously. How long the pumps will remain in operation can be set in the "time set" section of the co-aging menu.

To automatically start the equal aging application in circulation modes, the tasma seviye and the adjacent C terminal must be short-circuited. If this is not done, a "waiting start" warning will appear on the screen. The start-stop dry contact information from the boiler systems can be connected to these terminals to ensure control. If there is no external start-stop information, the overflow level terminals must be bridged.

If the circulation pump motors have ptc, they can be connected to the ptc terminals on the Hydropan panel. The ptc protection must be activated from the menu. After stopping the pump in error state, Hydropan panel activates the other circulation pump.

When the circulation pumps are in automatic mode in the co-aging application, the pumps in automatic mode are activated sequentially depending on the time set in the menu. When the automatic mode is deactivated, the relevant pump can be manually activated by pressing the test button once, the test button must be pressed again to deactivate it.

It can also be connected to the automation system and when the pumps are not in automatic mode, pump 1 is activated when the pressure switch 1 terminals are short-circuited with the relay dry contact output and pump 2 is activated when the pressure switch 2 terminals are short-circuited with the relay dry contact output. When the pressure switch terminals are open-circuited, the pumps are deactivated.

Automatic mode can be activated and deactivated separately for each pump via modbus rtu. In this way, if the co-aging time is set to 1 hour or more in the co-aging menu, when 2 pumps are set to automatic mode, 1 pump is activated and co-aging is provided. If the co-aging time is set to 0, when 2 pumps are set to automatic mode, 2 pumps are activated and operation is provided. In addition, after manual mode selection via modbus rtu, pumps can be switched on and off separately.

5.10. Pumps Co-aging (Cyclic Change - Alternate Run) Menu

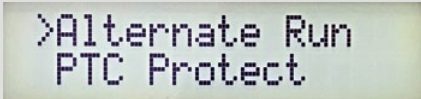

Figure 67. Alternate run menu selection

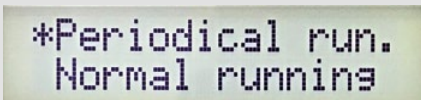

Figure 68. Alternate run selection screen

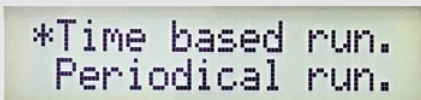

Figure 69. Alternate run selection screen

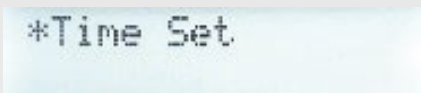

Figure 70. Alternate run selection screen

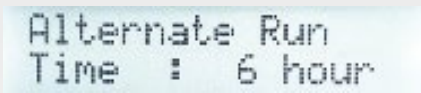

Figure 71. Alternate run selection screen

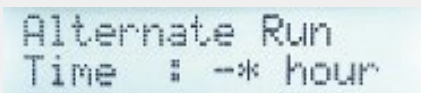

Figure 72. Alternate run selection screen

When the cursor is on the “Alternate Run” line on the Settings main screen, pressing the “Approval” displays the screen shown at the side and activates “Periodical run.” where the cursor is located. In periodical run mode, the pumps will be activated in sequence.

When the Up button is pressed and the cursor is moved to the “Time based run.” line, pressing the “Approval” button will activate the pumps in such a way that their operating hours are equalized and co-aging is performed.

When the Down button is pressed and the cursor is moved to the “Normal running” line, pressing the “Approval” button will disable the co-aging scenario and pump 1 will operate according to pressure switch 1 and pump 2 according to pressure switch 2.

Time set aging mode is only active when the operating mode circulation is selected. Aging times of circulation pumps can be adjusted via the “Time Set” menu. Initial loading value is 6 hours. While pump 1 and pump 2 are in automatic mode, pump 1 remains active for 6 hours. At the end of the period, pump 1 stops and pump 2 starts working for 6 hours. At the end of the period, pump 2 stops and pump 1 comes into operation. The cycle continues in this way. It can be set between 1-99 hours. If 0 is set and both pumps are in automatic mode, both pumps are activated.

5.11. PTC Protection Menu



Figure 73. PTC protection menu

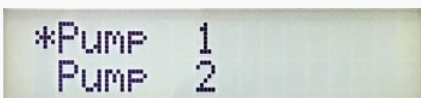

Figure 74. PTC protection pump selection screen



Figure 75. PTC protection setting display

When the cursor is on the PTC Protect line in the Settings menu, as shown in Figure 67, pressing the ‘Approval’ button will enter the PTC protection submenu.

After entering the PTC Protection submenu, as shown in Figure 68, use the up and down arrow keys to move the cursor to the relevant pump line then press the Approval button. As shown in Figure 69, select PTC protection or No PTC protection for the selected pump and press the confirm button.

5.12. Voltage Protection Menu

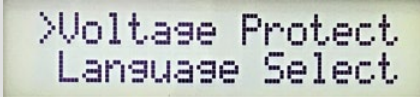

Figure 76. Voltage Protection Menu

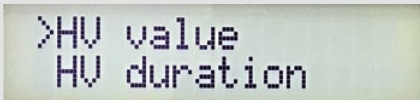

Figure 77. High Voltage Value Menu

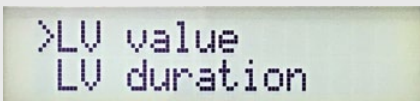

Figure 78. Low Voltage Value Menu

When the cursor is on the "Voltage Protect" line on the Settings main screen, pressing the "Confirm" button displays the screen shown at the side. Enter the "HV value" (High Voltage Value), "HV duration" (High Voltage Duration), "LV value" (Low Voltage Value), "LV duration" (Low Voltage Duration) submenus to set their values.

Use the HV value menu to set the upper limit value for protection against over voltage.

Use the HV duration menu to set the delay time before an high voltage error is given when the upper limit set for high voltage protection is exceeded.

Use the LV value menu to set the lower limit at which the protection against low voltage will be triggered. Use the LV duration menu to set the delay time before an low voltage error is given when the voltage falls below the lower limit set for low voltage protection. It is recommended not to change the factory settings.

5.13. Language Selection Menu

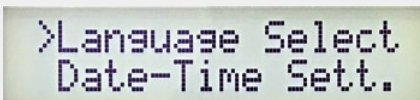

Figure 79. Language Selection Menu

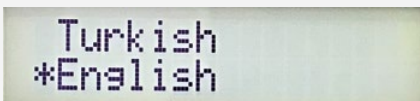

Figure 80. Language Selection Screen

Use the Language selection menu to select Turkish or English.

5.14. Date-Time Settings Menu

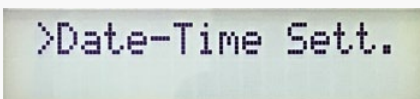

Figure 81. Time Setting Menu

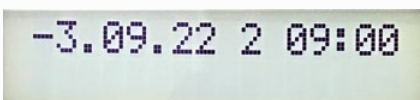

Figure 82. Time Setting Screen

Use the Date-Time setting menu to set date, day (1: Monday, 2: Tuesday, 3: Wednesday, etc.), and time.

6. Operation and Maintenance



- Disconnect electrical power and use the necessary protective equipment before performing any service or maintenance.
- The Hydropan panel energy input should use a residual current relay and appropriately rated circuit breaker. Check all terminal connections and functions during maintenance.
- Check that the electrical connections on the control panel are not loose and that the grounding wire is intact.
- Ensure there is no abrasion, puncture, or color change resulting from heating in the electrical cables.
- Always follow the pump and motor control instructions.
- You can view the product's history from the error history.
- Contact the authorized technical service for more detailed information.

7. Diagnostics and Troubleshooting

ERROR LIST	CAUSE	SOLUTION
<p>LOW CURRENT ERROR</p>	<ul style="list-style-type: none"> • The current drawn by the electric motor during operation is less than the limit value set in the Low curr. value (low current value) menu. 	<ul style="list-style-type: none"> • Switch all motors to manual mode by pressing button A. • Check past faults in the event log menu to understand the cause of the error. • Disconnect the electrical power to the panel. • Check that there is water in the tank. • Check if there is a strainer valf and clean it if it is clogged. • Make sure that water is entering the suction part of the pump. • Make sure that there is no air in the pump. If there is air, bleed the pump. • Check the coupling connection of the electric motor and pump system. • Make sure that the pump rotates smoothly. • Check that the valves on the suction and discharge sides are open. • Energize the panel. • Check the current drawn by the motor with a calibrated clamp ammeter. Press and hold the test button on the panel and compare the current value written on the panel screen with the current value written on the clamp ammeter. • The current drawn by the motor when running at load must not be less than the value set in the low current value menu. • For low current setting, refer to the description of the low current setting menu on the previous pages. • Close the suction valve while the engine is running and note how many amperes of current are drawn. The low current set point must be at least 10% greater than this value. Check that the mains voltage was at a normal level when the measurement was taken. • Open the suction valve, put all motors in automatic mode and observe that the system is working properly.

ERROR LIST	CAUSE	SOLUTION
HIGH CURRENT ERROR	<ul style="list-style-type: none"> The current drawn by the electric motor during operation is greater than the limit value set in the High curr. value (high current value) menu. 	<ul style="list-style-type: none"> Switch all motors to manual mode by pressing button A. Check past faults in the event log menu to understand the cause of the error. Disconnect the electrical power to the panel. Check the coupling connection of the electric motor and pump system. Make sure that the pump rotates smoothly. Check that the valves on the suction and discharge side are open. Check panel power supply, panel electric motor terminal connections, electric motor terminal connections and cables. Energize the panel. Check the current drawn by the motor with a calibrated clamp ammeter. Press and hold the test button on the panel and compare the current value written on the panel screen with the current value written on the clamp ammeter. The current drawn by the motor when running at load must not be greater than the value set in the high current value menu. For high current setting, refer to the description of the high current setting menu on the previous pages. Check that the current drawn by the electric motor at full load is not more than 10% more than the rated operating current indicated on the electric motor nameplate. Check that the mains voltage was at a normal level when the measurement was taken. If the electric motor is three-phase, check with measuring instruments that all 3 phases are supplied to the electric motor. Put all engines in automatic mode and observe that the system is working properly.
SWITCH ERROR	<ul style="list-style-type: none"> Attempts were made to switch more frequently than the maximum number of switches allowed in 1 hour set in the number of switches menu. The electric motor receives commands to switch on more frequently than the set switching limit. 	<ul style="list-style-type: none"> Check the expansion tank and observe that there is compressed air inside. If there is a fault, contact an authorized service center. Check the number of switching limit value in the menu. Check that the set limit value for the number of switches is set correctly according to the electric motor power. Make sure the system is working correctly. At the end of the time of the limit value set in the switch count menu, the switch error will clear automatically.
WATER FAILURE	<ul style="list-style-type: none"> The water has run out. The water in the tank ran out and the float terminals (C, AF, UF) in the panel became open circuit among themselves. 	<ul style="list-style-type: none"> Check the water level in the tank. Check that the float switch or level electrodes are in working order. Check the cable connections.
HIGH VOLTAGE ERROR	<ul style="list-style-type: none"> The mains voltage value is greater than the limit value set in the high voltage value menu. 	<ul style="list-style-type: none"> Measure the mains voltage with a calibrated voltmeter and compare it with the voltage values written on the panel display. Check the cable connections. The mains voltage values must be less than the limit value set in the high voltage value menu. This fault will automatically disappear when the mains voltage value drops below the limit value set in the high voltage value menu.

ERROR LIST	CAUSE	SOLUTION
LOW VOLTAGE ERROR	<ul style="list-style-type: none"> The mains voltage value is less than the limit value set in the low voltage value menu. 	<ul style="list-style-type: none"> Measure the mains voltage with a calibrated voltmeter and compare it with the voltage values written on the panel display. Check the cable connections. The mains voltage values must be greater than the limit value set in the low voltage value menu. This fault will automatically disappear when the mains voltage value is above the limit value set in the low voltage value menu.
PHASE FAILURE	<ul style="list-style-type: none"> One of the mains phases is missing. There is an imbalance between phases. 	<ul style="list-style-type: none"> Check the cable connections. Check with a measuring instrument that all 3 phases from the mains are coming to the panel. Check that the phase voltages are within the permissible values by measuring with a calibrated voltmeter. Check that the terminals are not loose, tighten if loose. This error will automatically disappear when the missing phase arrives.
PHASE ERROR	<ul style="list-style-type: none"> The phase order is reversed. 	<ul style="list-style-type: none"> Cut the power. Change the phase sequence. (Switch the two phases.) Give energy in a controlled way. Check the direction of rotation of the electric motor.
OVERFLOW ERROR	<ul style="list-style-type: none"> There is overflow. When the water level rose too high, the overflow float switch connected to the overflow level terminals of the panel rose and the overflow level terminals short-circuited among themselves. 	<ul style="list-style-type: none"> Check the water level. If there is overflow, drain the excess water in a controlled manner. When the overflow condition is eliminated, that is, when the overflow level terminals of the panel are open circuit among themselves, this error will automatically disappear.
BLOCKED ERROR	<ul style="list-style-type: none"> A blocking error can occur after high current, after low current retries, and after minimum pressure retries. 	<ul style="list-style-type: none"> Check the event log in the menu. Determine what the last error was before the blocking error. Follow the troubleshooting steps for the detected fault. Reset the system to verify that it is working properly.
PTC ERROR	<ul style="list-style-type: none"> The electric motor has overheated. 	<ul style="list-style-type: none"> Check the event log in the menu. Disconnect the electrical power and check that the motor rotates smoothly. Check the PTC cable connections. Make sure that the PTC sensor is functioning correctly. Check the temperature of the engine. Energize. Make sure that the high current value limit setting is made as described in the high current setting menu description. Prolonged high current draw causes the motor to overheat. Check that the electric motor does not draw more than 10% more current than the rated operating current indicated on the motor nameplate.

ERROR LIST	CAUSE	SOLUTION
LOW PRESSURE ERROR	<ul style="list-style-type: none"> The line pressure has not exceeded the minimum pressure value set in the minimum protection pressure menu. 	<ul style="list-style-type: none"> Switch all motors to manual mode by pressing button A. Check past faults in the event log menu to understand the cause of the error. Disconnect the electrical power to the panel. Check that there is water in the tank. Check if there is a strainer valve and clean it if it is clogged. Make sure that water is entering the suction part of the pump. Make sure that there is no air in the pump. If there is air, bleed the pump. Check the coupling connection of the electric motor and pump system. Make sure that the pump rotates smoothly. Check that the valves on the suction and discharge side are open. Energize the panel. Check that pressure rises when the pump starts. Check that the minimum protection pressure is set correctly.
HIGH PRESSURE ERROR	<ul style="list-style-type: none"> The line pressure is higher than the maximum pressure value set in the maximum protection pressure menu. 	<ul style="list-style-type: none"> Check the value set in the Maximum protection pressure menu. Observe that the pumps stop when the line pressure reaches the value set in the set pressure menu. This fault will automatically disappear when the line pressure drops below the maximum protective pressure value.
SENSOR ERROR	<ul style="list-style-type: none"> The pressure transmitter is defective or the cable connection is broken. 	<ul style="list-style-type: none"> The sensor disconnection fault can be given when the sensor status is in control mode, i.e. when the operating mode with the pressure transmitter is active. Check the pressure transmitter cable connections to the 4-20 mA sensor terminals of the panel. If the pressure transmitter is faulty, replace it with a new one. This error disappears automatically when the pressure transmitter fault is eliminated.
PUMP FAULT	<ul style="list-style-type: none"> Circulation pump is faulty. 	<ul style="list-style-type: none"> Pump error may occur in circulation mode. Pump error information is sent to the PTC terminals of the relevant pump. Check the circulation pump. If the circulation pump is faulty, make sure that the system stops safely. When the circulation pump malfunction is resolved and the error information coming to the PTC terminals disappears (when the PTC terminals are open circuit), this error will be automatically cleared.
WAITING START	<ul style="list-style-type: none"> This warning may appear in wet circulation or dry circulation mode. No start signal is received. 	<ul style="list-style-type: none"> For panel start in circulation mode, the overflow level and C terminals must be bridged together. When automatic start-up and shutdown of the system is required from boiler systems, the dry contact information from the boiler's pump operation must be connected to these terminals. The system starts when the panel start signal is received. If there is no boiler system and only panel-controlled equalization is desired, bridge the overflow level and C terminals.

8. Circuit Diagrams

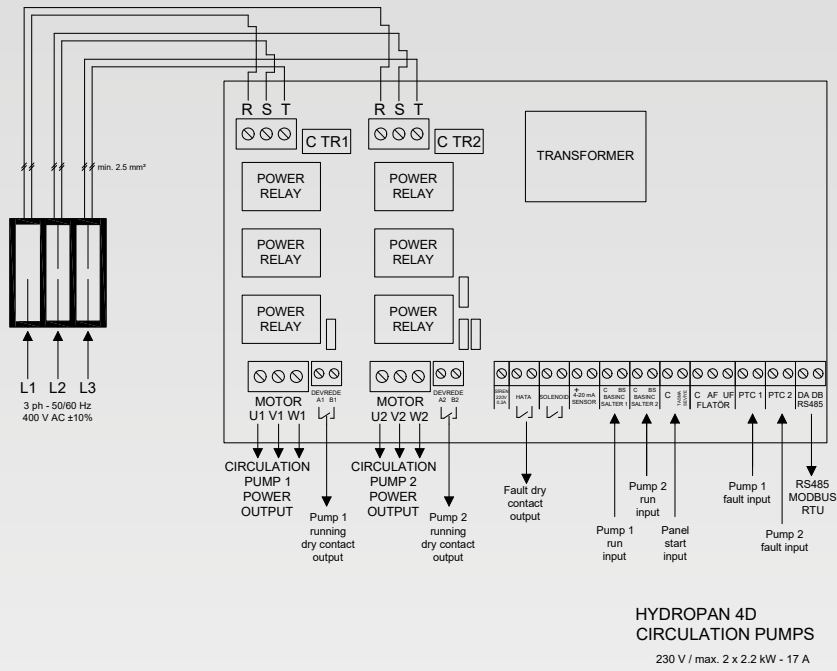

Figure 83. Hydropan Three-Phase Wiring Diagram - Booster

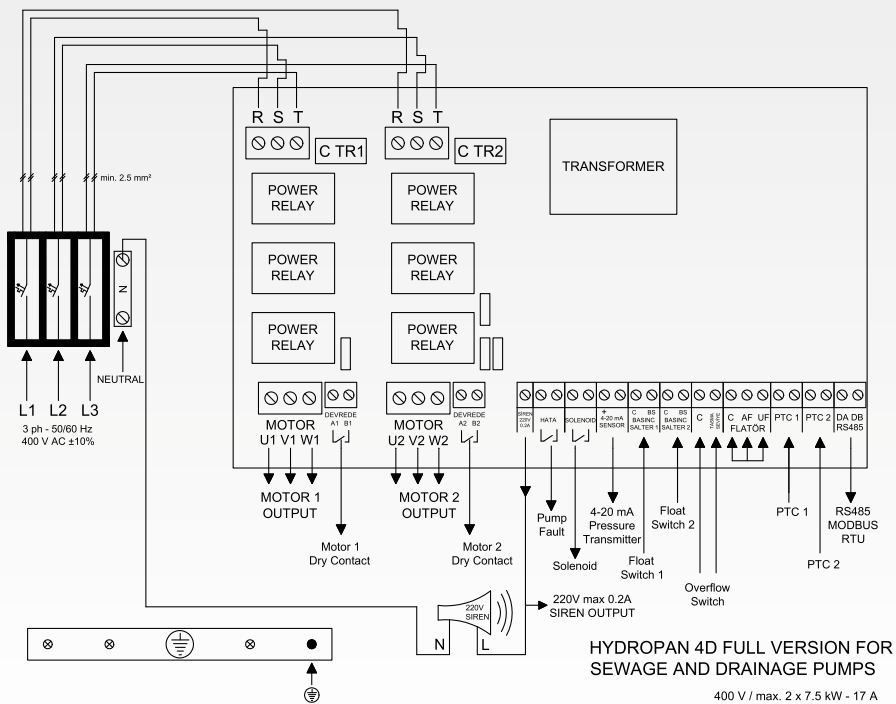

Figure 84. Hydropan Three-Phase Wiring Diagram - Sewage and Drainage

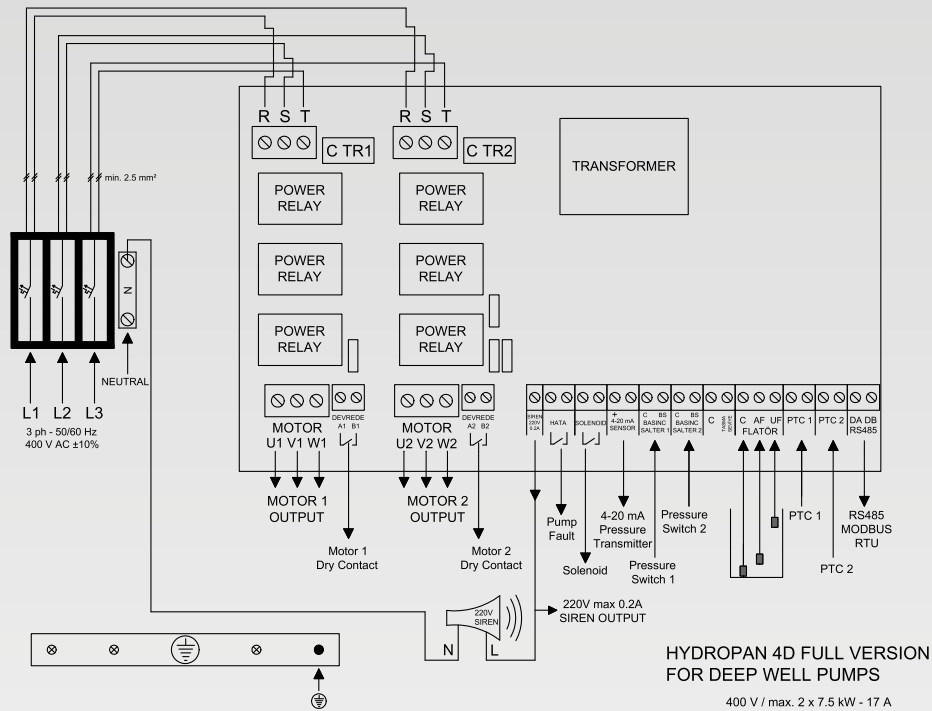

Figure 85. Hydroman Three-Phase Wiring Diagram - Deep Well

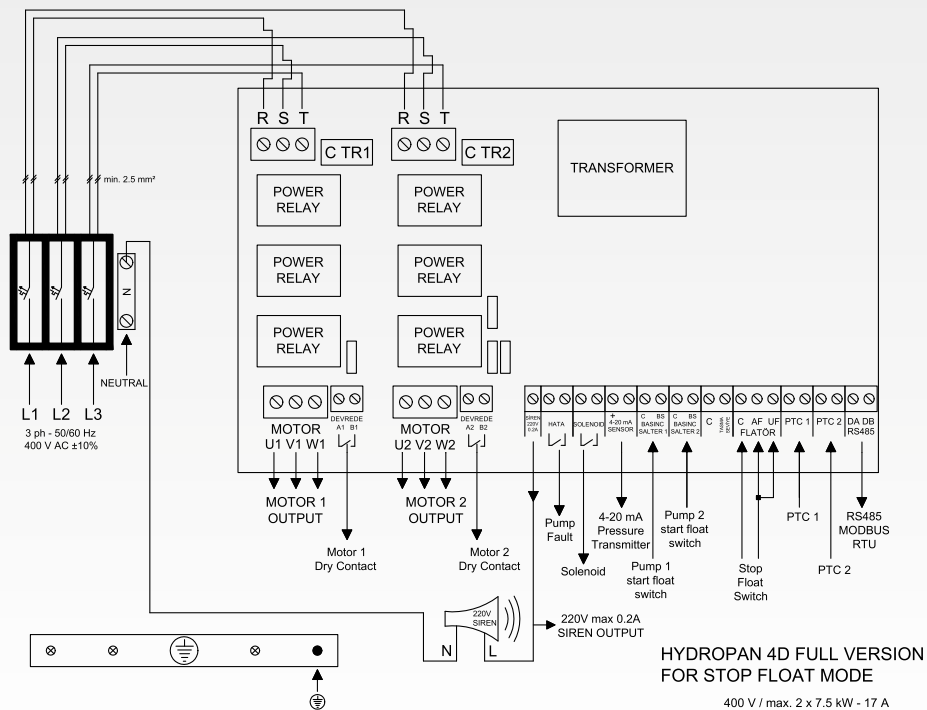

Figure 86. Hydroman Three-Phase Wiring Diagram - With Stop Float

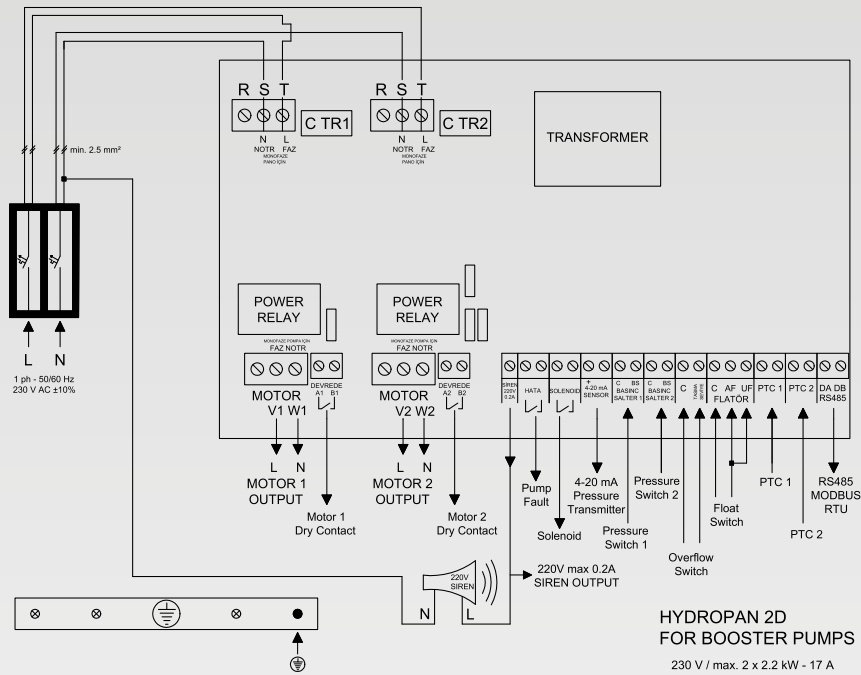

Figure 87. Hydroman Three-Phase Wiring Diagram - Circulation

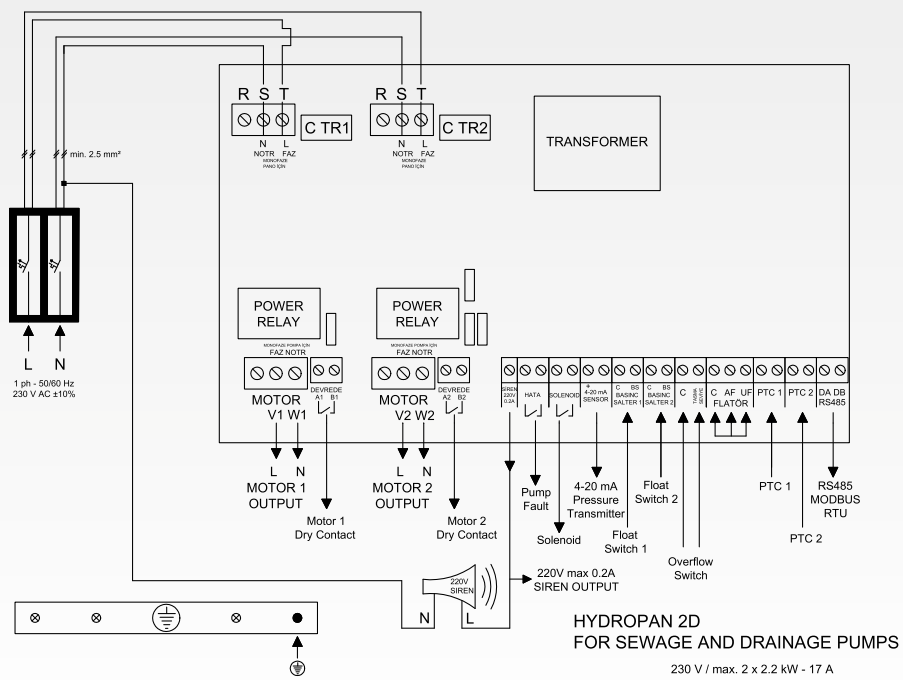

Figure 88. Hydroman Single-Phase Wiring Diagram - Booster

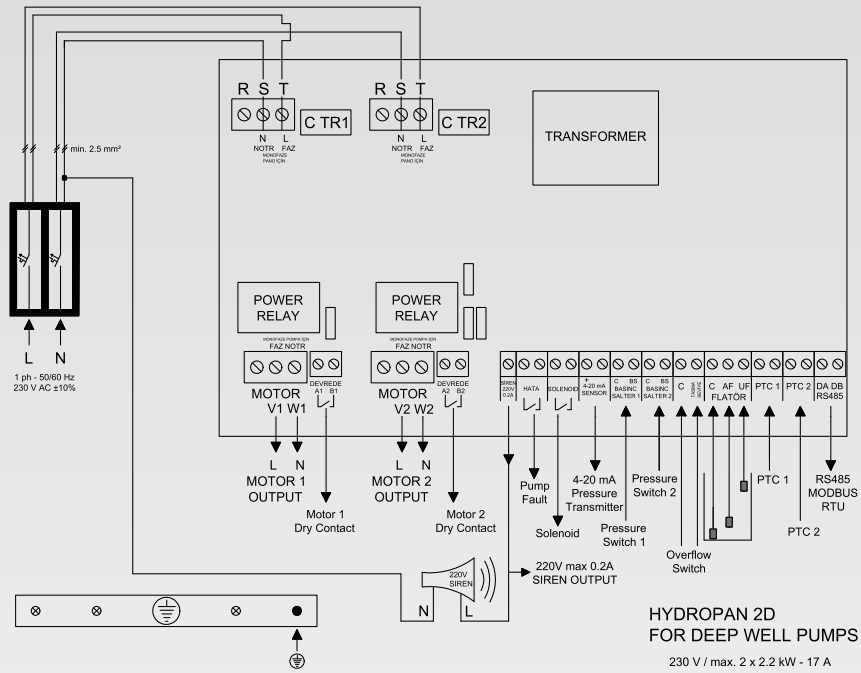

Figure 89. Hydroman Single-Phase Wiring Diagram - Sewage and Drainage

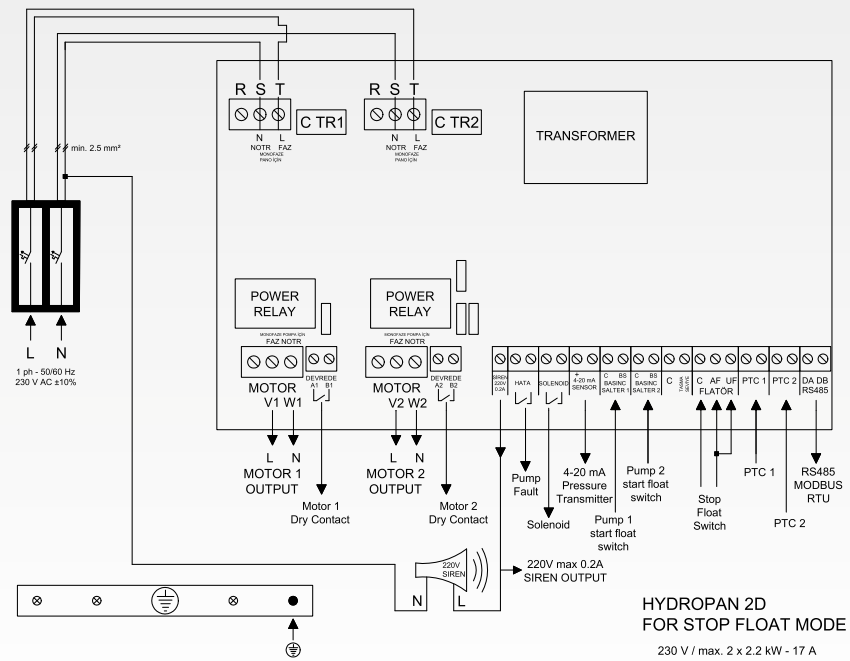

Figure 90. Hydroman Single-Phase Wiring Diagram - Deep Well

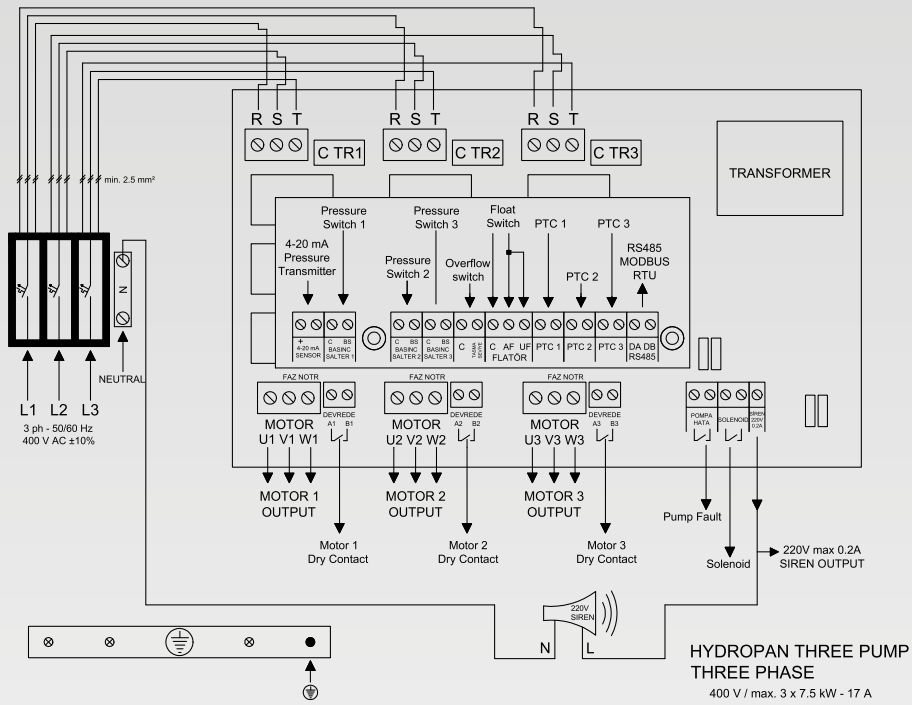

Figure 91. Hydropan Single-Phase Wiring Diagram - With Stop Float

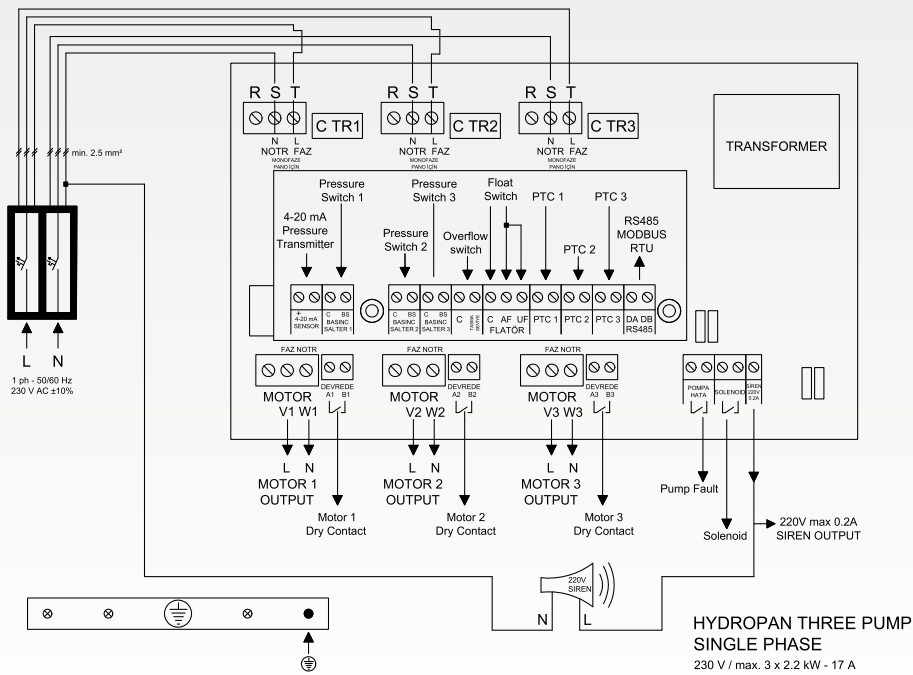

Figure 92. Hydropan Single-Phase Wiring Diagram - Circulation

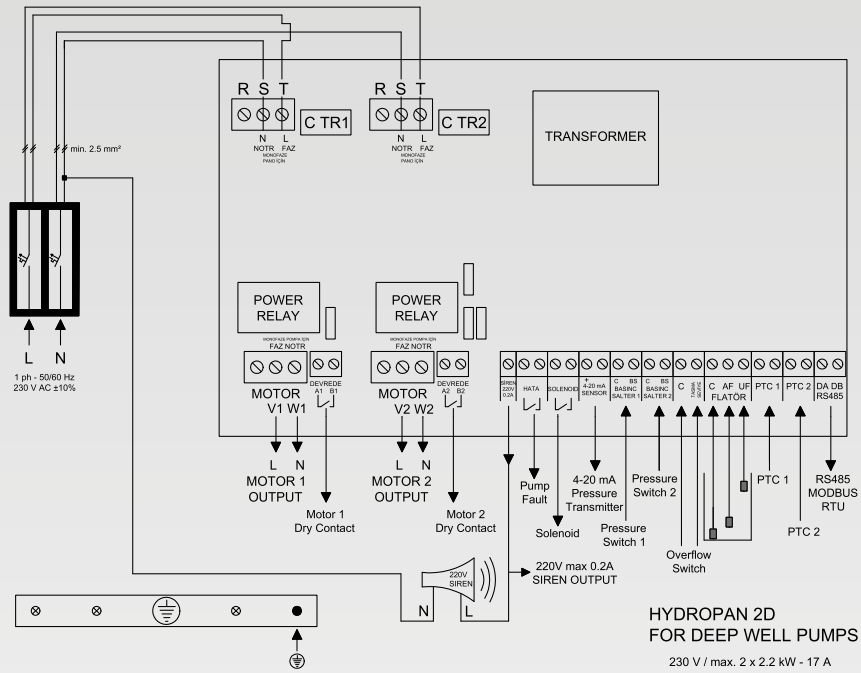

Figure 93. Hydropan 2DSC Single-Phase PSC Motor Wiring Diagram - Deep Well

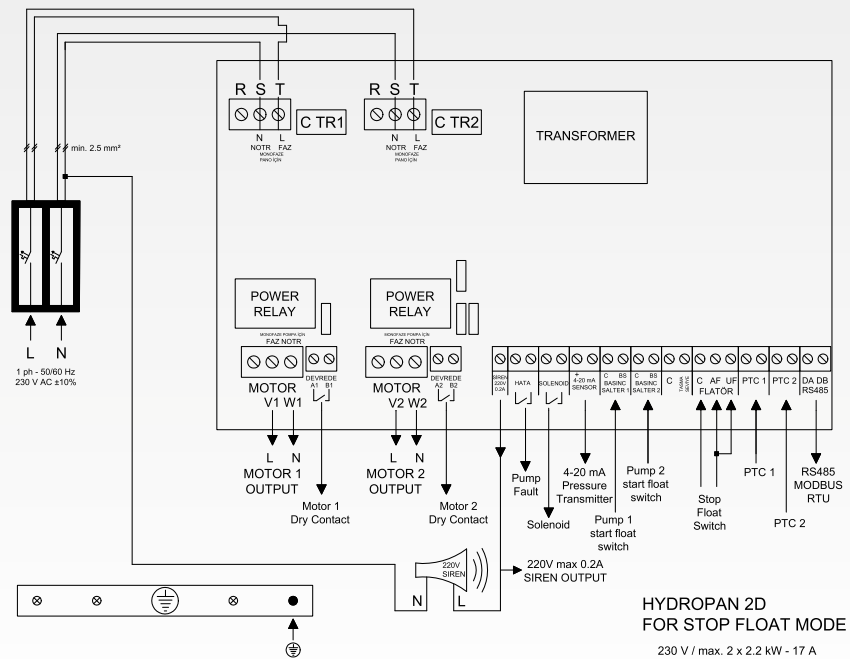

Figure 94. 3 Pump Hydropan Three-Phase Wiring Diagram - Booster

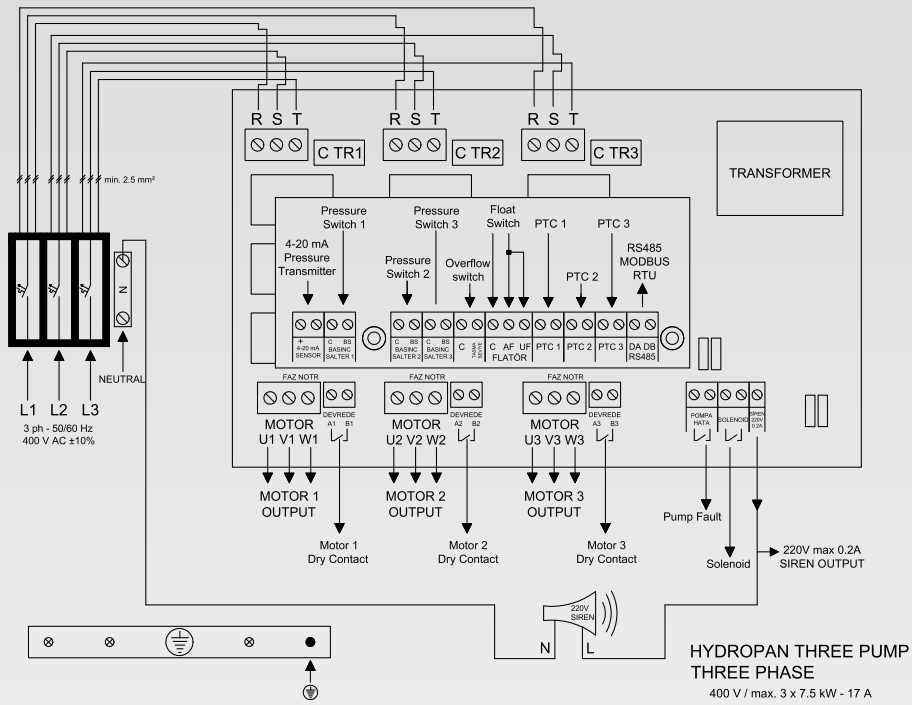

Figure 95. 3 Pump Hydropan Mono-Phase Wiring Diagram - Booster

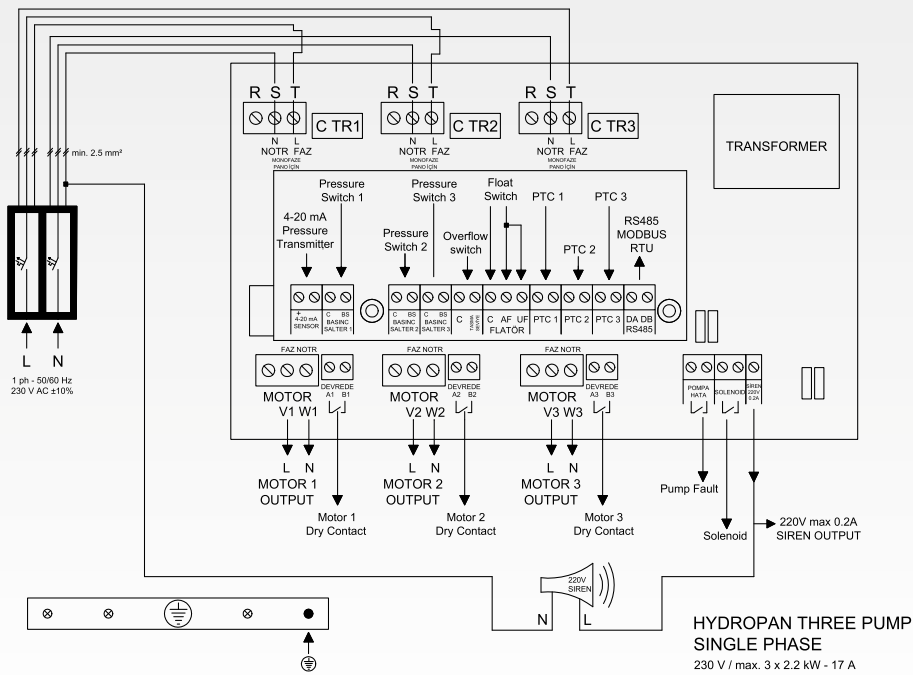

Figure 96. 3 Pump Hydropan Three-Phase Wiring Diagram - Circulation

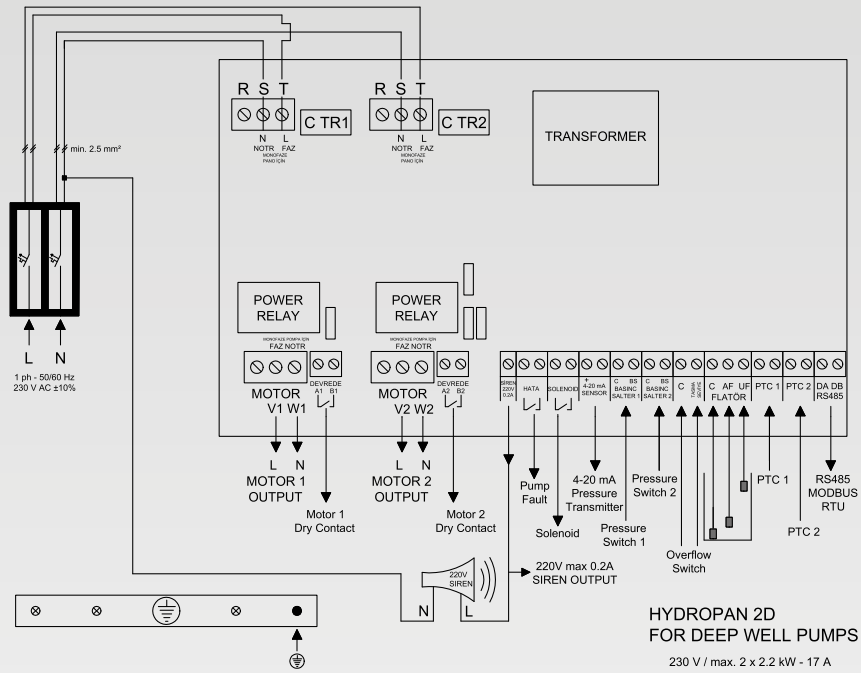

Figure 97. 3 Pump Hydropan Single-Phase Wiring Diagram - Circulation

9. Modbus Register Table

Register address	Function (R=Read, W=Write)	Information	Description (Software version R7V15)
40000	R	Weekly test program	1- Active, 0- Inactive
40001	R/W	Alternate run information	11- Time based running, 22- Periodical running, 33- Normal running
40002	R	General fault information	1- Fault, 0- No fault
40003	R	Phase error information	1- Phase error, 0- No phase error
40004	R	Water level information	1- No water, 0- Water present
40005	R	Sensor 1 error status	1- Sensor 1 is faulty, 0- No fault
40006	R	Low pressure error	1- Low pressure error, 0- No error
40007	R	High pressure error	1- High pressure error, 0- No error
40008	R	Phase sequence error	1- Phase sequence is incorrect, 0- No error
40009	R	Low pressure countdown	Counts down the time remaining for automatic reset of a low pressure error
40010	R	Operating mode	0- Booster mode, 1- Stop float mode, 2- Circulation wet, 3- Circulation dry
40011	R	Line pressure (An external pressure transmitter is required).	Incoming value x 0.1 = Line pressure (Bar)
40012	R/W	Pump 1 set pressure	Incoming value x 0.1 = Pump 1 set pressure (Bar)
40013	R/W	Pump 2 set pressure	Incoming value x 0.1 = Pump 2 set pressure (Bar)
40014	R	Pump 1 status information	11- Working, 22- Stopping, 33- Low current fault, 44- High current fault, 55- Weekly test in progress, 66- Pump blocked, 77- Ptc fault, 88- Waiting due to maximum switching number protection
40015	R	Pump 2 status information	11- Working, 22- Stopping, 33- Low current fault, 44- High current fault, 55- Weekly test in progress, 66- Pump blocked, 77- Ptc fault, 88- Waiting due to maximum switching number protection
40016	R	Pump 1 current information	Incoming value x 0.1 = Pump 1 current (A)
40017	R	Pump 2 current information	Incoming value x 0.1 = Pump 2 current (A)
40018	R	Pressure switch 1 status information	1- Run, 0- Stop
40019	R	Pressure switch 2 status information	1- Run, 0- Stop
40020	R/W	Pump 1 mode information	1- Automatic mode, 0- Manual mode
40021	R/W	Pump 2 mode information	1- Automatic mode, 0- Manual mode
40022	R	Pump 1 total operating time	Incoming value x 6 = Pump 1 total operating time (minutes)
40023	R	Pump 2 total operating time	Incoming value x 6 = Pump 2 total operating time (minutes)
40024	R	High voltage error	1- High voltage error, 0- No error

Register address	Function (R=Read, W=Write)	Information	Description
40025	R	Low voltage error	1- Low voltage error, 0- No error
40026	R	R phase voltage	R phase voltage (V)
40027	R	S phase voltage	S phase voltage (V)
40028	R	T phase voltage	T phase voltage (V)
40029	R	Low pressure protection time	Counts down the time remaining before switching to low pressure fault
40030	R	High pressure protection time	Counts down the time remaining before switching to high pressure fault
40031	R	Overflow error	1- Overflow error, 0- No error
40032	R/W	Pump 3 set pressure	Incoming value x 0.1 = Pump 3 set pressure (Bar)
40033	R	Pump 3 status information	11- Working, 22- Stopping, 33- Low current fault, 44- High current fault, 55- Weekly test in progress, 66- Pump blocked, 77- Ptc fault, 88- Waiting due to maximum switching number protection
40034	R	Pump 3 current information	Incoming value x 0.1 = Pump 3 current (A)
40035	R	Pressure switch 3 status information	1- Run, 0- Stop
40036	R/W	Pump 3 mode information	1- Automatic mode, 0- Manual mode
40037	R	Pump 3 total operating time	Incoming value x 6 = Pump 3 total operating time (minutes)
50	W	Software reset	1- Software reset
51	W	Sensor status selection	11- Sensor off, 22- Control mode, 33- Monitoring mode
52	W	Pump 1 differential pressure	Sent value x 0.1 = Pump 1 differential pressure (Bar) (1-150)
53	W	Pump 2 differential pressure	Sent value x 0.1 = Pump 2 differential pressure (Bar) (1-150)
54	W	Pump 3 differential pressure	Sent value x 0.1 = Pump 2 differential pressure (Bar) (1-150)
60	W	Pump 1 (Only in circulation mode)	1- Run, 0- Stop (The pump must be in manual mode)
61	W	Pump 2 (Only in circulation mode)	1- Run, 0- Stop (The pump must be in manual mode)
62	W	Pump 3 (Only in circulation mode)	1- Run, 0- Stop (The pump must be in manual mode)

Rev. 03/2026



Dudullu Organize Sanayi Bölgesi 2. Cadde No: 14
34775 Ümraniye İstanbul / Turkey
Tel : +90 216 561 47 74 (Pbx) • Fax : +90 216 561 47 50
www.etna.com.tr/en • info@etna.com.tr



ETNA®

0850 455 38 62
customer service